

VOLVO EXCAVATORS

EC250D, EC300D

23.5-33.1 t 188-231 hp



POWERFUL PERFORMANCE.



Increased power

Experience increased power and digging force as well as faster cycle times for greater productivity. Compared to the previous model, hydraulic pump flow has improved by 5% while digging force, swing torque and tractive force have increased by 3-5%. In the EC300D, engine power has increased by 11%.

Operate with increased power and digging force in Volvo's EC250D and EC300D. With faster cycle times and greater productivity, these machines will help you to get the job done faster. Whether you work in the quarry, road construction, site preparation or any other application, you'll experience high performance from these powerful machines.



Improved structure

For maximum durability and reliability, the boom and arm have been reinforced in critical areas to equally distribute mechanical stresses and handle the increased working power of these machines.

Electro-hydraulic system

New electro-hydraulic system and main control valve (MCV) use intelligent technology to control on-demand flow and reduce internal losses in the hydraulic circuit. This provides increased controllability, shorter cycle times and improved fuel efficiency.



Improved controllability

Both grading and combined operations have been improved thanks to Volvo's smart hydraulic system which increases controllability. Benefit from smoother and easier movement when traveling and lifting simultaneously as well as better grading quality from the harmonized boom and arm movement.

SAVE FUEL WITH VOLVO.

If you're looking for a fuel efficient and productive machine that will increase your competitive edge look no further than Volvo's latest offering. With proven, advanced technology the EC250D and EC300D offer customers a 7% - 10% increase in fuel efficiency compared to the previous model. Increase production, reduce fuel consumption and reach new levels of efficiency with Volvo.

Volvo D7 engine

Volvo's state-of-the-art D7 diesel engine is seamlessly integrated with all excavator systems. The premium, six cylinder engine delivers high performance and low fuel consumption. The D7 is available in two versions to comply with regional emission regulations.

Auto engine shutdown

The optional auto engine shutdown function automatically turns the engine off to reduce fuel consumption when the machine is inactive for a preset amount of time (five minutes is the default setting). The operator is informed one minute before this occurs.



Fuel consumption display

A new gauge bar on the I-ECU measures instantaneous fuel consumption while average fuel consumption is displayed numerically per hour. This allows you to monitor fuel usage on different job sites and applications.



Work modes

Volvo's unique, integrated work mode system now includes the G4 mode for optimum fuel efficiency and machine performance. Operators can choose the best work mode to suit the task at hand – simply select from I (Idle), F (Fine), G (General), H (Heavy) and P (Power max) mode.



ECO mode

Volvo's unique ECO mode contributes to up to 5% of the machine's total improved fuel efficiency – without any loss of performance in most operating conditions. The design features electronic pump control technology which reduces flow and pressure losses while maintaining digging power and maximizing swing torque.

THE VOLVO EXPERIENCE.

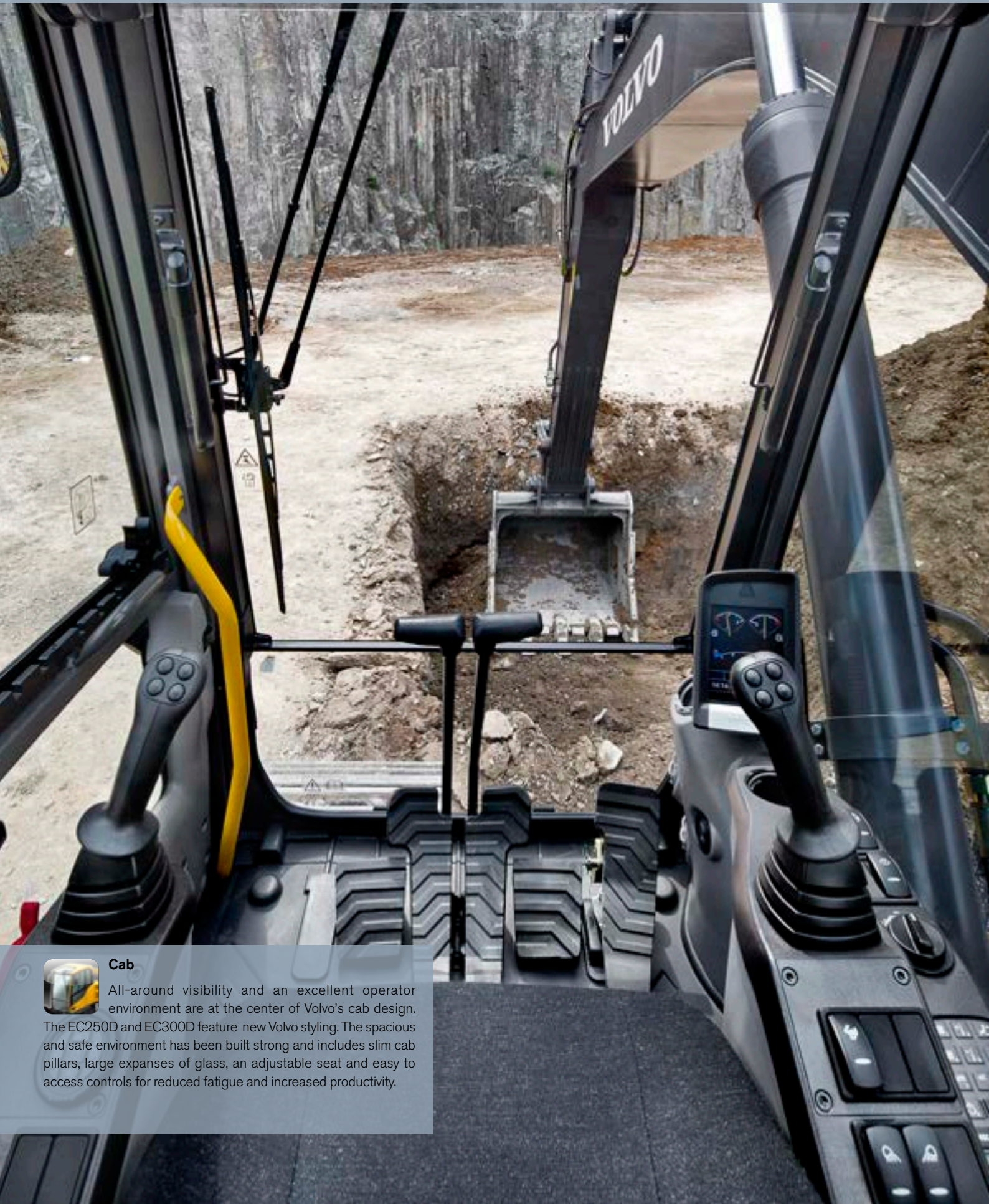

Cab

All-around visibility and an excellent operator environment are at the center of Volvo's cab design. The EC250D and EC300D feature new Volvo styling. The spacious and safe environment has been built strong and includes slim cab pillars, large expanses of glass, an adjustable seat and easy to access controls for reduced fatigue and increased productivity.

At Volvo we know that when operators are comfortable they experience less fatigue and work more productively. That's why the new, modern styling of the D-series cab provides superior visibility, a safe and spacious working environment and easy to access controls – right where you'd want them. Trust Volvo to think of everything and increase your productivity.

I-ECU monitor

The new, color LCD monitor displays machine status information including fuel consumption details and service interval alerts. The large, anti-glare, tiltable screen and conveniently placed navigation controls facilitate easy operation and high productivity.

Climate control system

Operators can set their ideal temperature with Volvo's powerful climate control system which is integrated into the I-ECU. Industry-leading air circulation and defrosting is delivered quickly via 14 well-spaced vents for increased comfort and productivity.



ROPS

Volvo recommends an optional Roll Over Protective Structure (ROPS) certified cab when working in challenging applications. This provides increased operator safety in the unlikely event of machine roll over.

Rearview camera

The optional rearview camera is mounted on the counterweight and reduces the blind spot behind the machine for increased safety. The image projects through the colour I-ECU monitor in the cab – avoiding the need for a second screen.

STRAIGHTFORWARD SERVICING.

With built in serviceability, the EC250D and EC300D help you to get the most out of each working day. Volvo engineers have designed these machines to make maintenance easy – with safe and easy access to centralized filters and grouped greasing points.

Cooling system

The radiator, charged air cooler and hydraulic oil cooler are situated side-by-side on a single layer to maximize efficiency, reduce blockages and aid cleaning. The system is easily accessed for maintenance by simply opening the side door from ground level.

Extra water separator

An additional water separator is available to further prevent water from entering the engine and impurities from contaminating the fuel. This feature provides increased water separation and filtration capacity for extra durability and reliability.

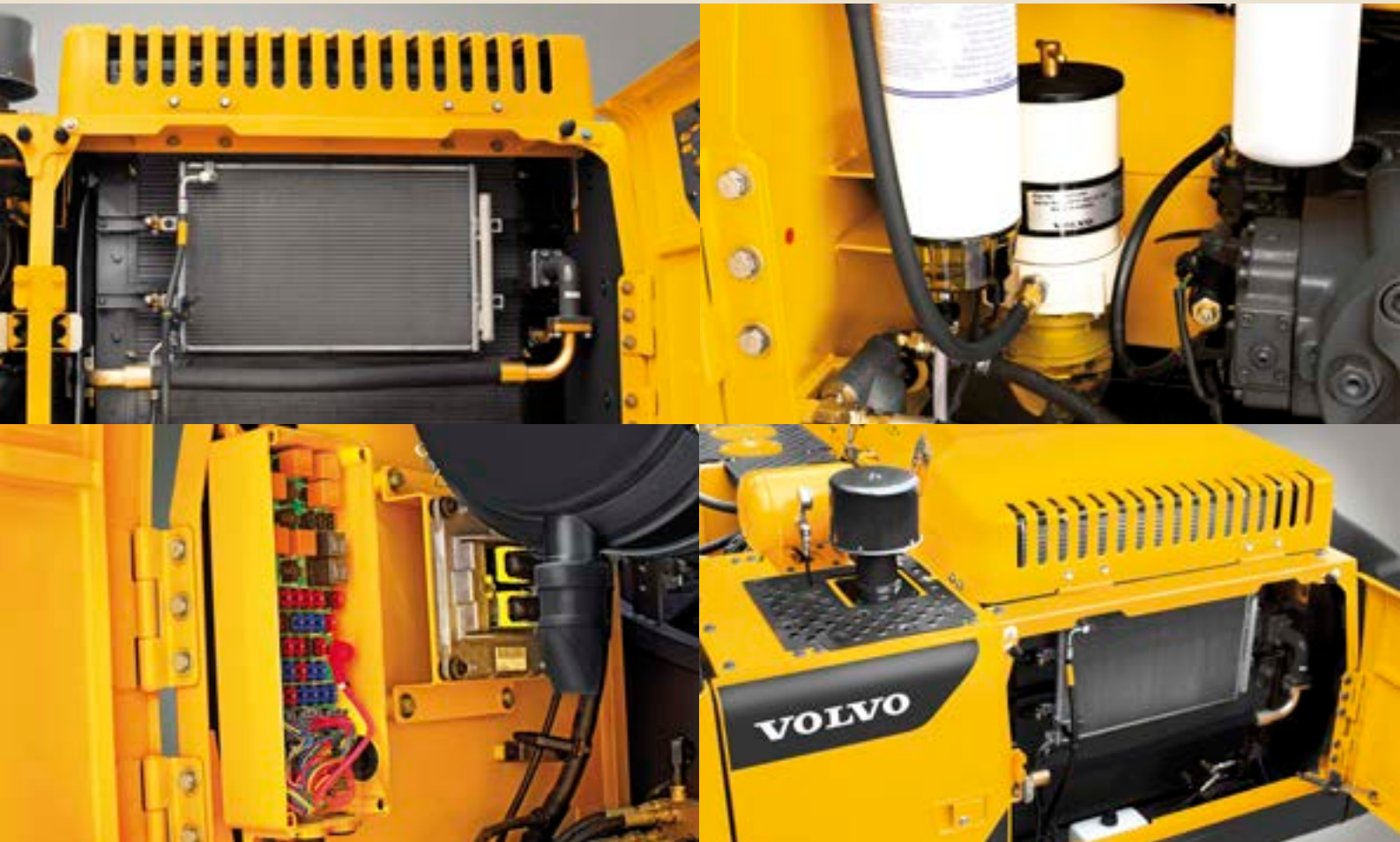

Electrical Distribution Box

The fully-sealed Electrical Distribution Box contains all fuses and relays – inside the box cover these are identified on a map. The Volvo design protects against dirt and moisture for more machine uptime. It is accessible from ground level for easy service access.

Air compressor

Particularly useful when working in dusty environments, this feature provides an air nozzle to clean inside the cab, as well as other areas, for operator comfort and easy maintenance.



Service access

Large doors and engine hood – which can be fully opened – provide easy service access to components. Centralized filters and greasing points allow regular checks to be done faster for maximum machine uptime and productivity. Durable, steel anti-slip plates ensure safe access for maintenance in more weather conditions and over time.

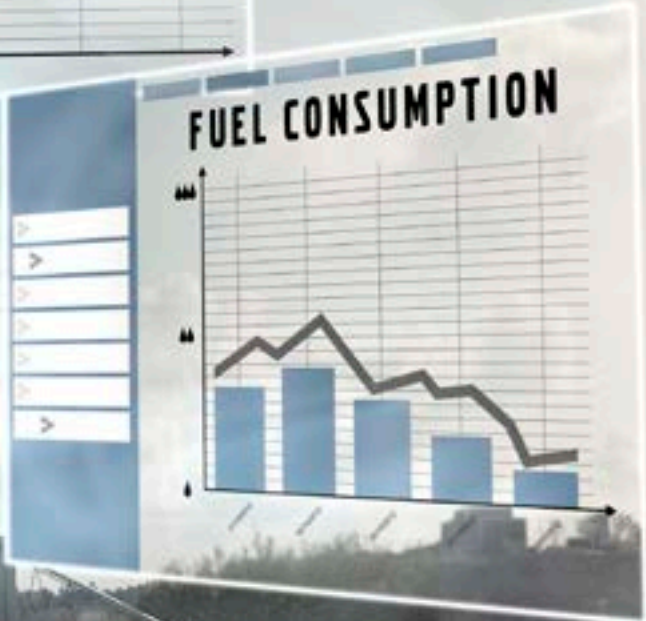

 **Customer Support Agreements**

The range of Customer Support Agreements offer preventive maintenance, total repairs and a number of uptime services. Volvo uses the latest technology to monitor machine operation and status, giving you advice to increase your profitability. By having a Customer Support Agreement you are in control of your service costs.

GET THE MOST FROM YOUR EXCAVATOR.

Maximize your excavator's productivity and profitability with Volvo's comprehensive range of attachments – designed to work in perfect harmony with Volvo machines. Access more applications and effectively perform a variety of tasks while experiencing reduced fuel consumption and reduced cycle times.



Volvo buckets

Volvo offers a range of high quality buckets designed to perform in a variety of materials. Featuring exceptional design and built in durability, Volvo buckets efficiently handle the toughest of jobs.

Hydraulic breakers

Volvo hydraulic breakers have been built to break the most demanding materials. With consistent power and high breaking force you'll benefit from maximum impact and durability. Set your Volvo breaker at the right frequency to suit your application needs.

INTERFACES



S1 and S2 quick couplers

Volvo's dedicated quick couplers are the ideal choice when you need high performance as well as the ability to easily switch between various attachments – including a tiltrotator. The lightweight design features a low build height and a tight fit to the attachment.



Universal quick coupler

For ultimate flexibility, the universal quick coupler picks up a wide range of both Volvo and other brand attachments. The coupler can be used with buckets in both the face shovel and backhoe position.



Direct fit

For maximum productivity when only operating in one application, Volvo's direct fit attachments provide the best performance and shortest tip radius.

BUCKETS & GROUND ENGAGING TOOLS



General purpose bucket

The perfect tool for digging and re-handling soft to medium material such as dirt, sand and loose clay soils.



Heavy-duty bucket

This bucket excels at digging compact materials including loose rock, hard clay and gravel. It can be used in applications such as quarrying or mining.



Volvo Tooth System

Volvo's robust range of teeth and adapters are designed to cover all applications.



Fixed ditching bucket

Ideal for ditch cleaning, grading, contouring, landscaping, backfilling and removing soft materials.



Tiltable ditching bucket

This bucket can be tilted 45° to each side making it ideal for use on slopes. It can be used for ditch cleaning, grading, contouring, landscaping, backfilling and removing soft materials.



Wear parts

For increased durability, Volvo provides segments, side shrouds, bottom shrouds, teeth, side cutters and bolt-on edges.

HYDRAULIC BREAKERS



Breaker package

The all-in-one hydraulic breaker package includes everything you need to start using your breaker. Depending on the machine, it contains a breaker, hydraulic hoses, a breaker bracket and tool.



Breaker Tools

Volvo hydraulic breakers can be used in a variety of applications. To ensure optimum performance in your application select the right breaker tool from the range.

FULL OF QUALITY FEATURES.



Customer solutions

Volvo provides the right solutions throughout the entire life cycle of your machine to lower total cost of ownership

Boom float

This option enables the boom to 'float' over the ground for easy controllability in grading and breaker operations.

New work modes

Volvo's unique work mode system now includes the G4 mode for optimum fuel efficiency and performance.



Increased power

Benefit from increased power, digging force and faster cycle times for more productivity.

Electro-hydraulic system

New electro-hydraulic system and MCV use intelligent technology to control on-demand flow for improved performance and efficiency.



Service access

Large doors and engine hood provide easy service access. Centralized filters and greasing points allow regular checks to be done faster.

New D-series styling

The EC250D and EC300D boast new, modern D-series styling consistent with Volvo's product family.





Improved structure

The boom and arm have been reinforced in critical areas to handle the increased working power of these machines.

New I-ECU

The large, color LCD monitor clearly displays machine status information for easy operation and increased productivity.



Cab design

All-around visibility, safety, comfort and easy to access controls are at the center of Volvo's operator environment.

Engine D7

Premium Volvo D7 diesel engine built with proven, advanced technology for high performance and low fuel consumption.

Optional track guard

When working in harsh environments, heavy-duty, bolt-on, full track roller guards protect the bottom rollers and links from debris.



ECO mode

Volvo's unique ECO mode contributes to up to 5% of the machine's total improved fuel efficiency without any loss of performance.

VOLVO EC250D, EC300D IN DETAIL.

	EC250D	EC300D
--	--------	--------

Engine

The engine, which provide excellent performance, is equipped with six cylinder, vertical, electronic-controlled high pressure fuel injectors, internal EGR* (*for certain regions), 7 liter in-line waste gate turbo charger, air-to-air intercooler and water cooled diesel engine type.

Engine	Volvo	D7	D7
Max power at	r/s / r/min	30 / 1 800	30 / 1 800
Net, ISO 9249/ SAE J1349	kW / hp	137 / 186	169 / 230
Gross, ISO 14396/ SAE J1995	kW / hp	138 / 188	170 / 231
Max torque at	Nm / r/min	870 / 1 350	1 080 / 1 350
No. of cylinders		6	6
Displacement	l	7.1	7.1
Bore	mm	108	108
Stroke	mm	130	130

Electrical system

High-capacity electrical system that is well protected. Waterproof double-lock harness plugs are used to secure corrosion-free connections. The main relays and solenoid valves are shielded to prevent damage. The master switch is standard.

Advanced monitoring of machine functions and important diagnostic information is displayed on the I-ECU.

	V	24	24
Voltage			
Battery capacity	V / Ah	2 x 12 / 200	2 x 12 / 200
Alternator	V / Ah	28 / 80	28 / 80
Start motor	V / kW	24 / 5.5	24 / 5.5

Swing system

The swing system uses an axial piston motors, driving a planetary gearbox for maximum torque. An automatic holding brake and anti-rebound valve are standard.

	r/min	11.9	10.7
Max. slew speed			
Max. slew torque	kNm	91.6	110.9

	EC250D	EC300D
--	--------	--------

Drive

Each track is powered by an automatic two-speed shift travel motor. The track brakes are multi-disc, spring-applied and hydraulic released. The travel motor, brake and planetary gears are well protected within the track frame.

Max. travel speed (low / high)	km/h	3.5 / 5.5	3.4 / 5.4
Max. drawbar pull	kN	217	247
Gradeability	°	35	35

Undercarriage

The undercarriage has a robust X-shaped frame. Greased and sealed track chains are standard.

	EC250DL	EC300DL
Track pads	2 x 51	2 x 50
Link pitch	190	203
Shoe width, triple grouser	600/700/ 800/900	600/700/ 800/900
Shoe width, triple grouser (HD)	-	600
Shoe width, double grouser	700	700
Bottom rollers	2 x 9	2 x 9
Top rollers	2 x 2	2 x 2
	EC250DLR	EC300DLR
Track pads	2 x 51	2 x 50
Link pitch	190	203
Shoe width, triple grouser	600/800/ 900	600/800/ 900
Shoe width, triple grouser (HD)	-	600
Shoe width, double grouser	700	-
Bottom rollers	2 x 9	2 x 9
Top rollers	2 x 2	2 x 2

	EC250D	EC300D
--	--------	--------

Hydraulic system

The new electro-hydraulic system and new MCV (main control valve) use intelligent technology to control on-demand flow for high-productivity, high-digging capacity and excellent fuel economy. The summation system, boom, arm and swing priority along with boom, arm and bucket regeneration provides optimum performance.

The following important functions are included in the system:

Summation system: Combines the flow of both hydraulic pumps to ensure quick cycle times and high productivity.

Boom priority: Gives priority to the boom operation for faster raising when loading or performing deep excavations.

Arm priority: Gives priority to the arm operation for faster cycle times in leveling and for increased bucket filling when digging.

Swing priority: Gives priority to swing functions for faster simultaneous operations.

Regeneration system: Prevents cavitation and provides flow to other movements during simultaneous operations for maximum productivity.

Power boost: All digging and lifting forces are increased.

Holding valves: Boom and arm holding valves prevent the digging equipment from creeping.

Main pump, Type 2 x variable displacement axial piston pumps			
Maximum flow	l/min	2 x 240	2 x 263
Pilot pump, Type Gear pump			
Maximum flow	l/min	1 x 18	1 x 18
Relief valve setting			
Implement	MPa	33.3/36.3	
Travel circuit	MPa	36.3	
Slew circuit	MPa	27.9	
Pilot circuit	MPa	3.9	

Hydraulic cylinders

Mono boom		2	2
Bore x Stroke	ø x mm	135 x 1 345	140 x 1 480
2 piece boom		1	1
Bore x Stroke	ø x mm	160 x 1 230	170 x 1 300
Arm		1	1
Bore x Stroke	ø x mm	140 x 1 665	150 x 1 745
Bucket		1	1
Bore x Stroke	ø x mm	130 x 1 150	140 x 1 140
Bucket for long reach		1	1
Bore x Stroke	ø x mm	100 x 865	100 x 865

	EC250D	EC300D
--	--------	--------

Service refill capacities

Fuel tank	l	470	470
Hydraulic system, total	l	400	400
Hydraulic tank	l	195	195
Engine oil	l	32	32
Engine coolant	l	41	41
Swing reduction unit	l	5.9	6
Travel reduction unit	l	2 x 5.0	2 x 6.8

Cab

The operator's cab has easy access via a wide door opening. The cab is supported on hydraulic dampening mounts to reduce shock and vibration levels. These along with sound absorbing lining provide low noise levels. The cab has excellent all-round visibility. The front windshield can easily slide up into the ceiling, and the lower front glass can be removed and stored in the side door.

Integrated air-conditioning and heating system: The pressurized and filtered cab air is supplied by an automatically-controlled fan. The air is distributed throughout the cab from 14 vents.

Ergonomic operator's seat: The adjustable seat and joystick console move independently to accommodate the operator. The seat has nine different adjustments plus a seat belt for the operator's comfort and safety.

Sound Level

Sound level in cab according to ISO 6396

LpA	dB(A)	71	
-----	-------	----	--

External sound level according to ISO 6395 and EU Noise Directive (2000/14/EC) and 474-1:2006 +A1:2009

LwA	dB(A)	104	105
-----	-------	-----	-----

SPECIFICATIONS.

DIMENSIONS

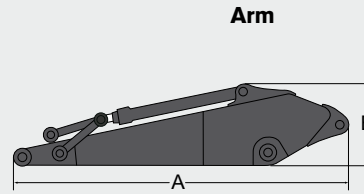
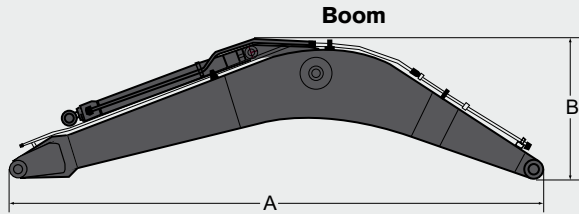

EC250D

Description	Unit	2 piece			Long reach	Description	Unit	2.5			2.97	3.6	Long reach
Boom	m	6.0	5.95	10.2		Arm	m	2.5	2.97	3.6	7.85		
Length (A)	mm	6 210	6 160	10 410		Length (A)	mm	3 590	4 060	4 730	9 000		
Height (B)	mm	1 630	1 100	1 525		Height (B)	mm	1 000	1 000	1 000	900		
Width	mm	740	740	740		Width	mm	500	500	500	480		
Weight	kg	2 360	2 840	3 010		Weight	kg	1 360	1 430	1 470	1 720		

EC300D

Description	Unit	XD			2 piece	Long reach	Description	Unit	XD			3.7	Long reach
Boom	m	6.2	6.2	6.2	10.2		Arm	m	2.55	2.75	3.05	3.7	7.9
Length (A)	mm	6 430	6 430	6 430	10 430		Length (A)	mm	3 710	3 870	4 150	4 150	4 900
Height (B)	mm	1 680	1 680	1 590	1 620		Height (B)	mm	1 010	1 010	1 010	1 010	1 050
Width	mm	770	770	770	770		Width	mm	545	545	545	545	545
Weight	kg	2 810	2 910	3 450	3 410		Weight	kg	1 530	1 590	1 590	1 690	1 660

* Includes cylinder, piping and pin, excludes boom cyl. Pin

* Includes cylinder, linkage and pin

BUCKET SELECTION GUIDE

Bucket type		Capacity	Cutting width	Tip radius	Weight	Teeth	EC250DL		
							6.0m Boom		
							600mm shoe, 4 950kg counterweight		
		L	mm	mm	kg	EA	2.5m	2.97m	3.6m
Direct fit Buckets	General purpose	560	600	1 623	808	3	C	C	C
		1 140	1 200	1 623	1 119	5	C	C	C
		1 320	1 350	1 623	1 199	5	C	C	C
		1 510	1 500	1 623	1 297	5	C	C	B
		1 690	1 650	1 623	1 379	5	C	B	B
	Heavy duty	1 760	1 700	1 623	1 436	6	B	B	A
		1 010	1 100	1 623	1 140	5	D	D	D
		1 140	1 200	1 623	1 198	5	D	D	D
		1 320	1 350	1 623	1 283	5	D	D	D
		1 510	1 500	1 623	1 369	5	D	C	B
Bucket type		Capacity	Cutting width	Tip radius	Weight	Teeth	EC300DL		
							6.2m Boom		
							600mm shoe, 5 500kg counterweight		
		L	mm	mm	kg	EA	2.55m	3.05m	3.7m
Direct fit Buckets	General purpose	550	600	1 627	826	3	C	C	C
		1 140	1 200	1 627	1 136	5	C	C	C
		1 320	1 350	1 627	1 215	5	C	C	C
		1 510	1 500	1 627	1 312	5	C	C	B
		1 690	1 650	1 627	1 395	5	C	B	A
	Heavy duty	1 760	1 700	1 627	1 453	6	C	B	A
		1 010	1 100	1 627	1 154	5	D	D	D
		1 140	1 200	1 627	1 211	5	D	D	D
		1 320	1 350	1 627	1 297	5	D	D	C
		1 510	1 500	1 627	1 383	5	D	C	B
1 690	1 650	1 627	1 469	5	C	B	A		

Please consult with your Volvo dealer for the proper match of buckets and attachments to suit the application.

The recommendations are given as a guide only, based on typical operation conditions.

Bucket capacity based on ISO 7451, heaped material with a 1:1 angle of repose.

Maximum material density

A	1200~1300 kg/m ³	Coal, Caliche, Shale
B	1400~1600 kg/m ³	Wet earth and clay, Limestone, Sandstone
C	1700~1800 kg/m ³	Granite, Wet sand, Well blasted rock
D	1900 kg/m ³ ~	Wet mud, Iron ore

MACHINE WEIGHTS AND GROUND PRESSURE

EC250DL		6.0m boom 2.97m arm 999kg (1 340l) bucket 4 250kg counterweight				6.0m boom 2.97m arm 999kg (1 340l) bucket 4 950kg counterweight			
Description	Shoe width	Operating weight	Ground pressure	Overall width	Shoe width	Operating weight	Ground pressure	Overall width	
	mm	kg	kPa	mm	mm	kg	kPa	mm	
Triple grouser	600	25 210	48.6	3 190	600	25 910	50.0	3 190	
	700	25 510	42.2	3 290	700	26 210	43.3	3 290	
	800	25 810	37.3	3 390	800	26 510	38.4	3 390	
	900	26 110	33.6	3 490	900	26 810	34.5	3 490	
Double grouser	700	25 790	42.6	3 290	700	26 490	43.8	3 290	
EC250DLR		10.2m boom 7.85m arm 458kg (520l) bucket 6 200kg counterweight							
Description	Shoe width	Operating weight	Ground pressure	Overall width					
	mm	kg	kPa	mm					
Triple grouser	600	27 500	53.1	3 190					
	800	28 100	40.7	3 390					
	900	28 410	36.5	3 490					
EC300DL		6.2m boom 3.05m arm 1 301kg (1 350l) bucket 5 100kg counterweight				6.2m boom 3.05m arm 1 301kg (1 350l) bucket 5 500kg counterweight			
Description	Shoe width	Operating weight	Ground pressure	Overall width	Shoe width	Operating weight	Ground pressure	Overall width	
	mm	kg	kPa	mm	mm	kg	kPa	mm	
Triple grouser	600	29 840	57.6	3 190	600	30 240	58.3	3 190	
	HD 600	30 040	58.0	3 190	HD 600	30 440	58.7	3 190	
	700	30 400	50.3	3 290	700	30 800	50.9	3 290	
	800	30 780	44.5	3 390	800	31 180	45.1	3 390	
	900	31 150	40.1	3 490	900	31 550	40.6	3 490	
Double grouser	700	30 550	50.5	3 290	700	30 950	51.2	3 290	
EC300DLR		10.2m boom 7.9m arm 478kg (570l) bucket 6 800kg counterweight							
Description	Shoe width	Operating weight	Ground pressure	Overall width					
	mm	kg	kPa	mm					
Triple grouser	600	31 380	60.5	3 190					
	HD 600	31 580	60.9	3 190					
	800	32 320	46.8	3 390					
	900	32 690	42.0	3 490					

SPECIFICATIONS.

WORKING RANGES

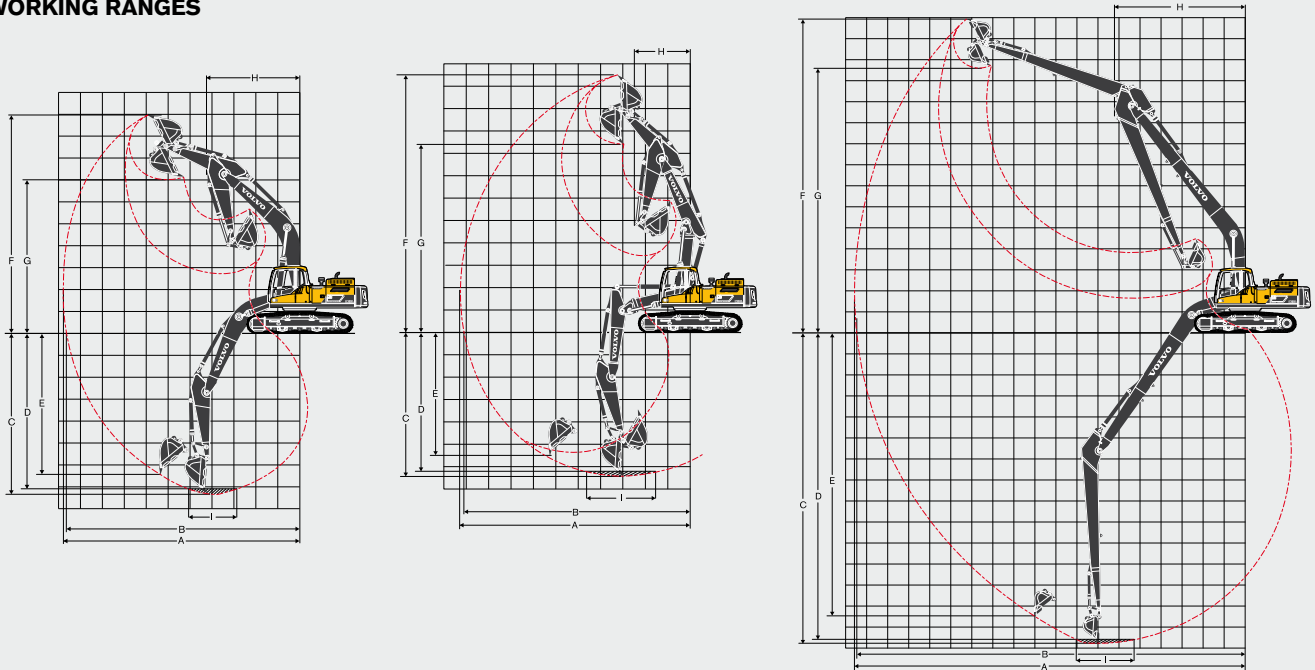

Description		Unit	EC250DL						EC250DLR		
Boom		m	6.0 mono		5.95 2 piece		10.2				
Arm		m	2.5	2.97	3.6	2.5	2.97	3.6	7.85		
A	Max. digging reach	mm	9 880	10 260	10 730	9 890	10 290	10 780	18 310		
B	Max. digging reach on ground	mm	9 690	10 080	10 560	9 710	10 110	10 610	18 210		
C	Max. digging depth	mm	6 500	6 980	7 600	6 040	6 480	7 050	14 350		
D	Max. digging depth (l = 2440 mm level)	mm	6 280	6 740	7 380	5 930	6 380	6 950	14 230		
E	Max. vertical wall digging depth	mm	5 650	5 930	6 250	5 050	5 450	5 950	12 780		
F	Max. cutting height	mm	9 620	9 690	9 660	11 080	11 340	11 580	14 890		
G	Max. dumping height	mm	6 700	6 800	6 820	8 010	8 270	8 530	12 740		
H	Min. front swing radius	mm	3 910	3 890	3 890	2 790	2 550	2 720	5 720		
Digging forces with direct fit bucket											
Bucket radius		mm	1 537	1 537	1 537	1 537	1 537	1 537	1 537		
Breakout force - bucket	Normal	SAE J1179	kN	152	152	152	152	152	152	68.6	
	Power boost	SAE J1179	kN	166	166	166	166	166	166	-	
	Normal	ISO 6015	kN	171	171	171	171	171	171	77.8	
	Power boost	ISO 6015	kN	186	186	186	186	186	186	-	
Tearout force - dipper arm	Normal	SAE J1179	kN	133	115	103	133	115	103	44.1	
	Power boost	SAE J1179	kN	145	125	112	145	125	112	-	
	Normal	ISO 6015	kN	137	118	105	137	118	105	44.7	
Power boost	ISO 6015	kN	149	129	114	149	129	114	-		
Rotation angle, bucket		°	178	178	178	178	178	178	178		
Description		Unit	EC300DL						EC300DLR		
Boom		m	6.2 mono		6.2 2 piece		10.2				
Arm		m	2.55	2.75	3.05	3.7	2.55	3.05	3.7	7.9	
A	Max. digging reach	mm	10 190	10 430	10 720	11 320	10 250	10 780	11 400	18 590	
B	Max. digging reach on ground	mm	9 980	10 230	10 520	11 140	10 050	10 590	11 210	18 480	
C	Max. digging depth	mm	6 850	7 050	7 350	8 000	6 210	6 740	7 380	14 750	
D	Max. digging depth (l = 2440 mm level)	mm	6 610	6 840	7 160	7 840	6 110	6 640	7 290	14 650	
E	Max. vertical wall digging depth	mm	5 730	5 890	6 480	7 090	5 210	5 800	6 430	13 490	
F	Max. cutting height	mm	9 660	9 910	10 080	10 360	11 600	12 100	12 600	14 940	
G	Max. dumping height	mm	6 670	6 870	7 040	7 320	8 360	8 850	9 350	12 600	
H	Min. front swing radius	mm	4 220	4 230	4 180	4 240	2 750	2 580	2 770	6 190	
Digging forces with direct fit bucket											
Bucket radius		mm	1 600	1 600	1 600	1 600	1 600	1 600	1 600	1 600	
Breakout force - bucket	Normal	SAE J1179	kN	168	168	168	168	168	168	69.1	
	Power boost	SAE J1179	kN	182	182	182	182	182	182	-	
	Normal	ISO 6015	kN	188	188	188	188	188	188	80.3	
	Power boost	ISO 6015	kN	205	205	205	205	205	205	-	
Tearout force - dipper arm	Normal	SAE J1179	kN	157	144	132	115	157	132	115	51.3
	Power boost	SAE J1179	kN	170	157	143	125	170	143	125	-
	Normal	ISO 6015	kN	161	148	135	118	161	135	118	51.8
Power boost	ISO 6015	kN	176	161	147	128	176	147	128	-	
Rotation angle, bucket		°	179	179	179	179	179	179	179	179	

DIMENSIONS

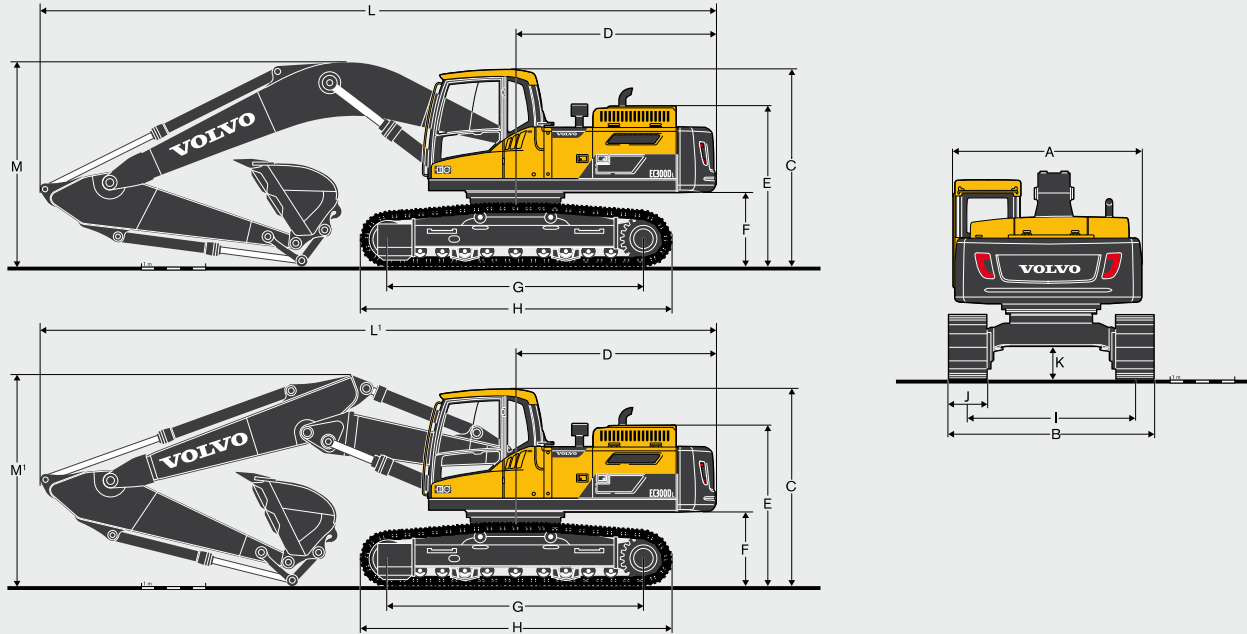

Description	Unit	EC250DL			EC250DLR
		6.0 mono or 5.95 2 piece	2.97	3.6	10.2
Boom	m				
Arm	m	2.5	2.97	3.6	7.85
A. Overall width of upper structure	mm	2 890	2 890	2 890	2 890
B. Overall width	mm	3 190	3 190	3 190	3 190
C. Overall height of cab	mm	3 020	3 020	3 020	3 020
D. Tail slew radius	mm	3 070	3 070	3 070	3 150
E. Overall height of engine hood	mm	2 450	2 450	2 450	2 450
F. Counterweight clearance *	mm	1 080	1 080	1 080	1 080
G. Tumbler length	mm	3 850	3 850	3 850	3 850
H. Track length	mm	4 650	4 650	4 650	4 650
I. Track gauge	mm	2 590	2 590	2 590	2 590
J. Shoe width	mm	600	600	600	600
K. Min. ground clearance *	mm	470	470	470	470
L. Overall length	mm	10 340	10 260	10 330	14 555
L'. Overall length	mm	10 290	10 260	10 330	-
M. Overall height of boom	mm	3 390	3 190	3 400	3 085
M'. Overall height of boom	mm	3 270	3 190	3 410	-
Description	Unit	EC300DL			EC300DLR
		6.2 mono or 6.2 2 piece	2.75	3.05	10.2
Boom	m				
Arm	m	2.55	2.75	3.05	3.7
A. Overall width of upper structure	mm	2 890	2 890	2 890	2 890
B. Overall width	mm	3 190	3 190	3 190	3 190
C. Overall height of cab	mm	3 090	3 090	3 090	3 090
D. Tail slew radius	mm	3 120	3 120	3 120	3 200
E. Overall height of engine hood	mm	2 510	2 510	2 510	2 510
F. Counterweight clearance *	mm	1 135	1 135	1 135	1 135
G. Tumbler length	mm	4 015	4 015	4 015	4 015
H. Track length	mm	4 870	4 870	4 870	4 870
I. Track gauge	mm	2 590	2 590	2 590	2 590
J. Shoe width	mm	600	600	600	600
K. Min. ground clearance *	mm	480	480	480	480
L. Overall length	mm	10 640	10 580	10 530	10 570
L'. Overall length	mm	10 635	-	10 570	10 570
M. Overall height of boom	mm	3 495	3 450	3 350	3 590
M'. Overall height of boom	mm	3 360	-	3 300	3 530

* Without shoe grouser

¹ 2-piece boom

SPECIFICATIONS.

LIFTING CAPACITY EC250DL

Lifting capacity at the arm end without bucket.

For lifting capacity including bucket, simply subtract actual weight of the direct fit bucket or the bucket with quick coupler from the following values.

	Lifting point	1.5 m		3.0 m		4.5 m		6.0 m		7.5 m		9.0 m		Max. reach				
		Along	Across	Along	Across	Along	Across	Along	Across	Along	Across	Along	Across	Along	Across	mm		
Boom 6.0m	7.5 m	kg														*6 860	6 440	6 117
Arm 2.5m	6.0 m	kg							*6 820	6 620						*6 860	4 830	7 235
Shoe 600mm	4.5 m	kg					*9 220	*9 220	*7 660	6 370	6 730	4 480				6 150	4 090	7 914
CWT 4 250kg	3.0 m	kg					*11 910	9 180	*8 870	6 040	6 570	4 340				5 640	3 720	8 265
	1.5 m	kg					*14 010	8 610	8 990	5 750	6 410	4 190				5 480	3 590	8 330
	0 m	kg					14 090	8 390	8 790	5 560	6 300	4 090				5 630	3 670	8 116
	-1.5 m	kg			*10 430	*10 430	14 070	8 370	8 720	5 500	6 280	4 070				6 170	4 010	7 600
	-3.0 m	kg			*18 650	17 140	*13 510	8 490	8 800	5 580						7 470	4 810	6 711
	-4.5 m	kg			*14 940	*14 940	*10 890	8 800								*9 050	7 030	5 255
Boom 6.0m	7.5 m	kg														*6 090	5 720	6 629
Arm 2.97m	6.0 m	kg							*6 230	*6 230	*6 300	4 630				*5 830	4 440	7 671
Shoe 600mm	4.5 m	kg					*8 310	*8 310	*7 120	6 460	*6 590	4 530				5 720	3 810	8 313
CWT 4 250kg	3.0 m	kg					*11 020	9 380	*8 380	6 120	6 620	4 370				5 280	3 490	8 648
	1.5 m	kg					*13 380	8 730	9 050	5 790	6 430	4 200				5 130	3 360	8 710
	0 m	kg					14 110	8 400	8 800	5 570	6 290	4 080				5 240	3 420	8 506
	-1.5 m	kg	*6 660	*6 660	*10 680	*10 680	14 010	8 320	8 690	5 470	6 240	4 030				5 680	3 690	8 016
	-3.0 m	kg	*12 360	*12 360	*17 770	16 890	*13 960	8 390	8 720	5 500						6 700	4 320	7 179
	-4.5 m	kg			*16 670	*16 670	*11 960	8 630								*8 890	5 920	5 844
Boom 6.0m	7.5 m	kg														*5 080	5 070	7 239
Arm 3.6m	6.0 m	kg									*5 600	4 760				*4 930	4 060	8 203
Shoe 600mm	4.5 m	kg							*6 380	*6 380	*6 020	4 630				*4 990	3 530	8 806
CWT 4 250kg	3.0 m	kg			*15 660	*15 660	*9 780	9 680	*7 700	6 250	6 700	4 440	5 010	3 320		4 900	3 240	9 122
	1.5 m	kg					*12 410	8 910	*9 070	5 880	6 480	4 250	4 910	3 220		4 760	3 120	9 181
	0 m	kg			*7 100	*7 100	*14 080	8 440	8 840	5 600	6 310	4 090				4 830	3 150	8 988
	-1.5 m	kg	*6 850	*6 850	*10 840	*10 840	13 950	8 260	8 660	5 450	6 210	4 000				5 170	3 350	8 526
	-3.0 m	kg	*11 080	*11 080	*16 030	*16 030	13 960	8 270	8 640	5 420	6 210	4 000				5 940	3 840	7 745
	-4.5 m	kg	*16 390	*16 390	*18 570	16 950	*12 980	8 440	8 770	5 540						7 730	4 950	6 531
	-6.0 m	kg					*9 480	8 860								*9 400	8 770	4 533
Boom 6.0m	7.5 m	kg							*6 800	*6 800						*6 860	*6 860	6 117
Arm 2.5m	6.0 m	kg							*6 820	*6 820						*6 860	5 200	7 235
Shoe 600mm	4.5 m	kg					*9 220	*9 220	*7 660	6 830	*7 030	4 830				6 550	4 420	7 914
CWT 4 950kg	3.0 m	kg					*11 910	9 870	*8 870	6 500	7 010	4 690				6 020	4 030	8 265
	1.5 m	kg					*14 010	9 300	9 590	6 210	6 850	4 540				5 860	3 900	8 330
	0 m	kg					*14 790	9 080	9 380	6 030	6 740	4 440				6 020	3 990	8 116
	-1.5 m	kg			*10 430	*10 430	*14 590	9 060	9 320	5 970	6 720	4 420				6 600	4 350	7 600
	-3.0 m	kg			*18 650	18 470	*13 510	9 180	9 400	6 040						7 980	5 210	6 711
	-4.5 m	kg			*14 940	*14 940	*10 890	9 490								*9 050	7 580	5 255
Boom 6.0m	7.5 m	kg														*6 090	*6 090	6 629
Arm 2.97m	6.0 m	kg							*6 230	*6 230	*6 300	4 980				*5 830	4 780	7 671
Shoe 600mm	4.5 m	kg					*8 310	*8 310	*7 120	6 930	*6 590	4 880				*5 860	4 120	8 313
CWT 4 950kg	3.0 m	kg					*11 020	10 070	*8 380	6 580	7 050	4 720				5 640	3 780	8 648
	1.5 m	kg					*13 380	9 410	*9 630	6 250	6 870	4 550				5 480	3 660	8 710
	0 m	kg					*14 570	9 090	9 390	6 030	6 730	4 430				5 610	3 720	8 506
	-1.5 m	kg	*6 660	*6 660	*10 680	*10 680	*14 720	9 000	9 280	5 930	6 670	4 380				6 080	4 010	8 016
	-3.0 m	kg	*12 360	*12 360	*17 770	*17 770	*13 960	9 080	9 320	5 960						7 160	4 690	7 179
	-4.5 m	kg			*16 670	*16 670	*11 960	9 320								*8 890	6 400	5 844
Boom 6.0m	7.5 m	kg														*5 080	*5 080	7 239
Arm 3.6m	6.0 m	kg									*5 600	5 110				*4 930	4 370	8 203
Shoe 600mm	4.5 m	kg							*6 380	*6 380	*6 020	4 980				*4 990	3 820	8 806
CWT 4 950kg	3.0 m	kg			*15 660	*15 660	*9 780	*9 780	*7 700	6 710	*6 710	4 790	5 350	3 600		*5 210	3 520	9 122
	1.5 m	kg					*12 410	9 600	*9 070	6 340	6 920	4 600	5 250	3 500		5 090	3 400	9 181
	0 m	kg			*7 100	*7 100	*14 080	9 130	9 430	6 060	6 740	4 440				5 180	3 430	8 988
	-1.5 m	kg	*6 850	*6 850	*10 840	*10 840	*14 680	8 950	9 260	5 910	6 640	4 350				5 540	3 650	8 526
	-3.0 m	kg	*11 080	*11 080	*16 030	*16 030	*14 360	8 950	9 230	5 890	6 650	4 350				6 360	4 170	7 745
	-4.5 m	kg	*16 390	*16 390	*18 570	18 270	*12 980	9 120	9 370	6 010						8 260	5 360	6 531
	-6.0 m	kg					*9 480	*9 480								*9 400	*9 400	4 533

Notes: 1. Machine in "Fine Mode-F" (Power Boost) for lifting capacities. 2. The above loads are in compliance with SAE J1097 and ISO 10567 Hydraulic Excavator Lifting Capacity Standards. 3. Rated loads do not exceed 87% of hydraulic lifting capacity or 75% of tipping load. 4. Rated loads marked with an asterisk (*) are limited by hydraulic capacity rather than tipping load.

LIFTING CAPACITY EC250DL

Lifting capacity at the arm end without bucket.

For lifting capacity including bucket, simply subtract actual weight of the direct fit bucket or the bucket with quick coupler from the following values.

	Lifting point		1.5 m		3.0 m		4.5 m		6.0 m		7.5 m		9.0 m		Max. reach		
			Along	Across	Along	Across	Along	Across	Along	Across	Along	Across	Along	Across	Along	Across	mm
Boom 6.0m	7.5 m	kg							*6 800	*6 800					*6 860	*6 860	6 117
Arm 2.5m	6.0 m	kg							*6 820	*6 820					*6 860	5 300	7 235
Shoe 800mm	4.5 m	kg					*9 220	*9 220	*7 660	6 960	*7 030	4 930			6 700	4 510	7 914
CWT 4 950kg	3.0 m	kg					*11 910	10 070	*8 870	6 640	7 170	4 790			6 160	4 120	8 265
	1.5 m	kg					*14 010	9 500	9 800	6 340	7 000	4 640			5 990	3 990	8 330
	0 m	kg					*14 790	9 280	9 600	6 160	6 890	4 540			6 160	4 080	8 116
	-1.5 m	kg			*10 430	*10 430	*14 590	9 260	9 530	6 100	6 880	4 520			6 750	4 450	7 600
	-3.0 m	kg			*18 650	*18 650	*13 510	9 380	9 620	6 170					8 160	5 330	6 711
	-4.5 m	kg			*14 940	*14 940	*10 890	9 690							*9 050	7 740	5 255
Boom 6.0m	7.5 m	kg													*6 090	*6 090	6 629
Arm 2.97m	6.0 m	kg							*6 230	*6 230	*6 300	5 080			*5 830	4 880	7 671
Shoe 800mm	4.5 m	kg					*8 310	*8 310	*7 120	7 060	*6 590	4 980			*5 860	4 210	8 313
CWT 4 950kg	3.0 m	kg					*11 020	10 270	*8 380	6 710	*7 190	4 820			5 770	3 870	8 648
	1.5 m	kg					*13 380	9 610	*9 630	6 390	7 020	4 650			5 610	3 740	8 710
	0 m	kg					*14 570	9 280	9 610	6 160	6 890	4 530			5 740	3 800	8 506
	-1.5 m	kg	*6 660	*6 660	*10 680	*10 680	*14 720	9 200	9 500	6 070	6 830	4 480			6 220	4 100	8 016
	-3.0 m	kg	*12 360	*12 360	*17 770	*17 770	*13 960	9 270	9 530	6 100					7 330	4 800	7 179
	-4.5 m	kg			*16 670	*16 670	*11 960	9 510							*8 890	6 530	5 844
Boom 6.0m	7.5 m	kg													*5 080	*5 080	7 239
Arm 3.6m	6.0 m	kg									*5 600	5 210			*4 930	4 460	8 203
Shoe 800mm	4.5 m	kg							*6 380	*6 380	*6 020	5 080			*4 990	3 900	8 806
CWT 4 950kg	3.0 m	kg			*15 660	*15 660	*9 780	*9 780	*7 700	6 840	*6 710	4 890	5 470	3 680	*5 210	3 600	9 122
	1.5 m	kg					*12 410	9 790	*9 070	6 470	7 080	4 700	5 370	3 580	5 210	3 480	9 181
	0 m	kg			*7 100	*7 100	*14 080	9 330	9 650	6 190	6 900	4 540			5 300	3 510	8 988
	-1.5 m	kg	*6 850	*6 850	*10 840	*10 840	*14 680	9 140	9 480	6 040	6 800	4 450			5 670	3 740	8 526
	-3.0 m	kg	*11 080	*11 080	*16 030	*16 030	*14 360	9 150	9 450	6 020	6 800	4 450			6 510	4 270	7 745
	-4.5 m	kg	*16 390	*16 390	*18 570	*18 570	*12 980	9 320	9 580	6 140					8 450	5 480	6 531
	-6.0 m	kg					*9 480	*9 480							*9 400	*9 400	4 533

Notes: 1. Machine in "Fine Mode-F" (Power Boost) for lifting capacities. 2. The above loads are in compliance with SAE J1097 and ISO 10567 Hydraulic Excavator Lifting Capacity Standards. 3. Rated loads do not exceed 87% of hydraulic lifting capacity or 75% of tipping load. 4. Rated loads marked with an asterisk (*) are limited by hydraulic capacity rather than tipping load.

LIFTING CAPACITY EC250DLR

Lifting capacity at the arm end without bucket.

For lifting capacity including bucket, simply subtract actual weight of the direct fit bucket or the bucket with quick coupler from the following values.

	Lifting point		6.0 m		7.5 m		9.0 m		10.5 m		12.0 m		13.5 m		15.0 m		Max. reach		
			Along	Across	Along	Across	Along	Across	Along	Across	Along	Across	Along	Across	Along	Across	Along	Across	mm
Boom 10.2m	13.5 m	kg															*1 080	*1 080	12 441
Arm 7.85m	12.0 m	kg										*1 180	*1 180				*1 020	*1 020	13 702
Shoe 800mm	10.5 m	kg										*1 760	*1 760				*980	*980	14 701
CWT 6 200kg	9.0 m	kg										*2 110	*2 110	*1 380	*1 380		*970	*970	15 490
	7.5 m	kg									*2 340	*2 340	*2 310	2 280	*1 810	1 800	*960	*960	16 100
	6.0 m	kg									*2 520	*2 520	*2 430	2 190	*2 140	1 750	*980	*980	16 551
	4.5 m	kg							*2 940	*2 940	*2 730	2 610	*2 580	2 090	*2 440	1 680	*1 000	*1 000	16 855
	3.0 m	kg	*5 420	*5 420	*4 360	*4 360	*3 710	*3 710	*3 280	3 070	*2 980	2 450	*2 760	1 970	2 550	1 600	*1 040	*1 040	17 020
	1.5 m	kg	*6 630	6 280	*5 110	4 650	*4 210	3 590	*3 630	2 840	*3 230	2 280	*2 940	1 860	2 460	1 520	*1 100	*1 100	17 052
	0 m	kg	*7 600	5 600	*5 770	4 200	*4 670	3 280	*3 960	2 630	3 400	2 130	2 830	1 750	2 380	1 440	*1 170	1 120	16 950
	-1.5 m	kg	*8 250	5 160	*6 280	3 870	4 910	3 040	3 950	2 450	3 260	2 000	2 730	1 650	2 320	1 370	*1 270	1 120	16 711
	-3.0 m	kg	8 420	4 920	6 090	3 660	4 720	2 860	3 810	2 310	3 150	1 900	2 650	1 580	2 260	1 320	*1 410	1 140	16 331
	-4.5 m	kg	8 300	4 820	5 960	3 540	4 600	2 760	3 710	2 220	3 080	1 830	2 600	1 530	2 240	1 300	*1 590	1 200	15 798
	-6.0 m	kg	8 300	4 810	5 910	3 500	4 550	2 710	3 670	2 180	3 050	1 800	2 590	1 510	*2 040	1 300	*1 840	1 290	15 097
	-7.5 m	kg	8 370	4 880	5 940	3 520	4 560	2 720	3 670	2 180	3 050	1 810	2 610	1 540			*2 210	1 440	14 201
	-9.0 m	kg	*7 900	5 020	6 040	3 610	4 630	2 780	3 730	2 240	3 110	1 860					2 790	1 670	13 072
	-10.5 m	kg	*7 140	5 230	*5 790	3 760	4 760	2 900	3 840	2 350							3 370	2 060	11 638
	-12.0 m	kg	*6 000	5 530	*4 870	3 990	*3 960	3 100									*3 520	2 790	9 767

Notes: 1. Machine in "Fine Mode-F" (Power Boost) for lifting capacities. 2. The above loads are in compliance with SAE J1097 and ISO 10567 Hydraulic Excavator Lifting Capacity Standards. 3. Rated loads do not exceed 87% of hydraulic lifting capacity or 75% of tipping load. 4. Rated loads marked with an asterisk (*) are limited by hydraulic capacity rather than tipping load.

SPECIFICATIONS.

LIFTING CAPACITY EC300DL

Lifting capacity at the arm end without bucket.

For lifting capacity including bucket, simply subtract actual weight of the direct fit bucket or the bucket with quick coupler from the following values.

	Lifting point	1.5 m		3.0 m		4.5 m		6.0 m		7.5 m		9.0 m		Max. reach			
		Along	Across	Along	Across	Along	Across	Along	Across	Along	Across	Along	Across	mm			
Boom 6.2m	7.5 m	kg						*7 600	*7 600					*7 740	6 910	6 528	
Arm 2.55m	6.0 m	kg						*7 920	7 880	*7 700	5 380			*7 710	5 300	7 558	
Shoe 600mm	4.5 m	kg				*11 200	*11 200	*8 990	7 490	*8 000	5 250			7 150	4 520	8 185	
CWT 5 100kg	3.0 m	kg				*14 260	10 630	*10 370	7 020	8 050	5 030			6 590	4 120	8 500	
	1.5 m	kg				*16 330	9 920	11 030	6 630	7 820	4 820			6 420	3 980	8 540	
	0 m	kg				*16 890	9 690	10 760	6 400	7 670	4 690			6 600	4 070	8 308	
	-1.5 m	kg			*12 830	*12 830	*16 440	9 690	10 680	6 330	7 640	4 660			7 260	4 450	7 779
	-3.0 m	kg			*20 420	20 150	*15 070	9 860	10 800	6 430					8 790	5 350	6 883
	-4.5 m	kg			*16 190	*16 190	*12 070	10 260						*9 720	7 780	5 437	
Boom 6.2m	7.5 m	kg												*6 300	5 840	7 210	
Arm 3.05m	6.0 m	kg								*6 980	5 430			*6 030	4 640	8 152	
Shoe 600mm	4.5 m	kg						*8 280	7 560	*7 440	5 260			*6 010	4 010	8 736	
CWT 5 100kg	3.0 m	kg				*13 090	10 840	*9 720	7 060	8 040	5 010	5 970	3 700	5 930	3 680	9 032	
	1.5 m	kg				*15 540	9 970	11 020	6 610	7 780	4 770	5 860	3 600	5 790	3 560	9 069	
	0 m	kg				*16 600	9 580	10 680	6 310	7 580	4 600			5 930	3 620	8 851	
	-1.5 m	kg	*7 500	*7 500	*11 670	*11 670	*16 550	9 500	10 540	6 190	7 500	4 520			6 420	3 910	8 357
	-3.0 m	kg	*13 800	*13 800	*19 390	*19 390	*15 550	9 610	10 600	6 240	7 590	4 610			7 550	4 580	7 532
	-4.5 m	kg			*18 200	*18 200	*13 220	9 940	*9 630	6 500				*9 020	6 180	6 243	
Boom 6.2m	7.5 m	kg								*6 170	5 640			*4 950	*4 950	7 964	
Arm 3.7m	6.0 m	kg								*6 250	5 580			*4 760	4 110	8 824	
Shoe 600mm	4.5 m	kg						*7 420	*7 420	*6 810	5 380	6 180	3 900	*4 750	3 600	9 365	
CWT 5 100kg	3.0 m	kg				*11 690	11 280	*8 950	7 240	*7 620	5 110	6 040	3 770	*4 880	3 330	9 642	
	1.5 m	kg				*14 520	10 260	*10 460	6 740	7 850	4 830	5 890	3 630	*5 190	3 210	9 676	
	0 m	kg			*6 750	*6 750	*16 180	9 680	10 760	6 370	7 600	4 610	5 770	3 510	5 340	3 250	9 473
	-1.5 m	kg	*6 940	*6 940	*10 970	*10 970	*16 650	9 470	10 530	6 180	7 470	4 490	5 720	3 470	5 710	3 470	9 013
	-3.0 m	kg	*11 600	*11 600	*16 610	*16 610	*16 130	9 480	10 500	6 150	7 460	4 490			6 520	3 950	8 256
	-4.5 m	kg	*17 380	*17 380	*20 560	19 800	*14 460	9 710	10 670	6 300				8 280	5 010	7 102	
	-6.0 m	kg			*15 040	*15 040	*10 660	10 230						*8 610	8 050	5 292	
Boom 6.2m	7.5 m	kg						*7 600	*7 600					*7 740	7 150	6 528	
Arm 2.55m	6.0 m	kg						*7 920	*7 920	*7 700	5 580			*7 710	5 500	7 558	
Shoe 600mm	4.5 m	kg				*11 200	*11 200	*8 990	7 760	*8 000	5 450			7 380	4 700	8 185	
CWT 5 500kg	3.0 m	kg				*14 260	11 030	*10 370	7 290	8 310	5 230			6 810	4 290	8 500	
	1.5 m	kg				*16 330	10 320	11 380	6 900	8 080	5 030			6 630	4 150	8 540	
	0 m	kg				*16 890	10 080	11 110	6 660	7 920	4 890			6 830	4 250	8 308	
	-1.5 m	kg			*12 830	*12 830	*16 440	10 090	11 040	6 600	7 900	4 860			7 500	4 640	7 779
	-3.0 m	kg			*20 420	*20 420	*15 070	10 260	11 150	6 700					9 080	5 580	6 883
	-4.5 m	kg			*16 190	*16 190	*12 070	10 660						*9 720	8 080	5 437	
Boom 6.2m	7.5 m	kg								*6980	5 630			*6030	4 820	8 152	
Arm 3.05m	6.0 m	kg								*8280	7 830	*7440	5 460	*6010	4 180	8 736	
Shoe 600mm	4.5 m	kg						*13090	11 240	*9720	7 330	*8160	5 210	6 170	3 870	9 032	
CWT 5 500kg	3.0 m	kg				*15540	10 370	*11070	6 880	8 030	4 970	6 060	3 760	5 990	3 720	9 069	
	1.5 m	kg				*16600	9 980	11 040	6 580	7 840	4 800			6 130	3 780	8 851	
	0 m	kg				*16600	9 980	11 040	6 580	7 840	4 800			6 130	3 780	8 851	
	-1.5 m	kg	*7 500	*7500	*11670	*11670	*16550	9 890	10 900	6 460	7 760	4 730			6 650	4 090	8 357
	-3.0 m	kg	*13 800	*13800	*19390	*19390	*15550	10 010	10 950	6 510	7 850	4 810			7 800	4 780	7 532
	-4.5 m	kg			*18200	*18200	*13220	10 330	*9630	6 770				*9020	6 430	6 243	
Boom 6.2m	7.5 m	kg								*6 170	5 850			*4 950	*4 950	7 964	
Arm 3.7m	6.0 m	kg								*6 250	5 780			*4 760	4 280	8 824	
Shoe 600mm	4.5 m	kg						*7 420	*7 420	*6 810	5 580	6 380	4 060	*4 750	3 760	9 365	
CWT 5 500kg	3.0 m	kg				*11 690	11 680	*8 950	7 510	*7 620	5 310	6 250	3 930	*4 880	3 480	9 642	
	1.5 m	kg				*14 520	10 660	*10 460	7 010	8 110	5 030	6 090	3 790	*5 190	3 360	9 676	
	0 m	kg			*6 750	*6 750	*16 180	10 080	11 110	6 640	7 860	4 820	5 970	3 680	5 530	3 400	9 473
	-1.5 m	kg	*6 940	*6 940	*10 970	*10 970	*16 650	9 860	10 890	6 450	7 720	4 690	5 920	3 630	5 910	3 630	9 013
	-3.0 m	kg	*11 600	*11 600	*16 610	*16 610	*16 130	9 880	10 850	6 420	7 720	4 690			6 740	4 130	8 256
	-4.5 m	kg	*17 380	*17 380	*20 560	*20 560	*14 460	10 100	*10 740	6 560				*8 480	5 230	7 102	
	-6.0 m	kg			*15 040	*15 040	*10 660	10 620						*8 610	8 370	5 292	

Notes: 1. Machine in "Fine Mode-F" (Power Boost) for lifting capacities. 2. The above loads are in compliance with SAE J1097 and ISO 10567 Hydraulic Excavator Lifting Capacity Standards. 3. Rated loads do not exceed 87% of hydraulic lifting capacity or 75% of tipping load. 4. Rated loads marked with an asterisk (*) are limited by hydraulic capacity rather than tipping load.

LIFTING CAPACITY EC300DL

Lifting capacity at the arm end without bucket.

For lifting capacity including bucket, simply subtract actual weight of the direct fit bucket or the bucket with quick coupler from the following values.

	Lifting point		1.5 m		3.0 m		4.5 m		6.0 m		7.5 m		9.0 m		Max. reach		
			Along	Across	Along	Across	Along	Across	Along	Across	Along	Across	Along	Across	Along	Across	mm
Boom 6.2m	7.5 m	kg							*7 600	*7 600					*7 740	7 340	6 528
Arm 2.55m	6.0 m	kg							*7 920	*7 920	*7 700	5 740			*7 710	5 660	7 558
Shoe 800mm	4.5 m	kg					*11 200	*11 200	*8 990	7 970	*8 000	5 610			7 610	4 840	8 185
CWT 5 500kg	3.0 m	kg					*14 260	11 350	*10 370	7 500	8 570	5 390			7 030	4 430	8 500
	1.5 m	kg					*16 330	10 640	*11 590	7 110	8 340	5 190			6 850	4 290	8 540
	0 m	kg					*16 890	10 400	11 470	6 870	8 180	5 050			7 060	4 390	8 308
	-1.5 m	kg			*12 830	*12 830	*16 440	10 400	11 390	6 810	8 150	5 020			7 750	4 790	7 779
	-3.0 m	kg			*20 420	*20 420	*15 070	10 570	*11 370	6 910					9 380	5 750	6 883
	-4.5 m	kg			*16 190	*16 190	*12 070	10 970							*9 720	8 320	5 437
Boom 6.2m	7.5 m	kg													*6 300	6 220	7 210
Arm 3.05m	6.0 m	kg									*6 980	5 790			*6 030	4 970	8 152
Shoe 800mm	4.5 m	kg							*8 280	8 040	*7 440	5 620			*6 010	4 310	8 736
CWT 5 500kg	3.0 m	kg					*13 090	11 550	*9 720	7 540	*8 160	5 370	6 380	3 990	*6 220	3 970	9 032
	1.5 m	kg					*15 540	10 680	*11 070	7 090	8 290	5 130	6 260	3 890	6 190	3 840	9 069
	0 m	kg					*16 600	10 290	11 400	6 790	8 100	4 960			6 340	3 910	8 851
	-1.5 m	kg	*7 500	*7 500	*11 670	*11 670	*16 550	10 210	11 260	6 670	8 020	4 890			6 870	4 230	8 357
	-3.0 m	kg	*13 800	*13 800	*19 390	*19 390	*15 550	10 320	11 310	6 720	8 110	4 970			8 060	4 940	7 532
	-4.5 m	kg			*18 200	*18 200	*13 220	10 650	*9 630	6 980					*9 020	6 630	6 243
Boom 6.2m	7.5 m	kg									*6 170	6 010			*4 950	*4 950	7 964
Arm 3.7m	6.0 m	kg									*6 250	5 940			*4 760	4 410	8 824
Shoe 800mm	4.5 m	kg							*7 420	*7 420	*6 810	5 740	*6 410	4 190	*4 750	3 880	9 365
CWT 5 500kg	3.0 m	kg					*11 690	*11 690	*8 950	7 720	*7 620	5 470	6 450	4 060	*4 880	3 590	9 642
	1.5 m	kg					*14 520	10 970	*10 460	7 220	8 360	5 190	6 300	3 920	*5 190	3 480	9 676
	0 m	kg			*6 750	*6 750	*16 180	10 390	11 470	6 850	8 120	4 980	6 170	3 800	*5 690	3 520	9 473
	-1.5 m	kg	*6 940	*6 940	*10 970	*10 970	*16 650	10 180	11 250	6 660	7 980	4 850	6 130	3 760	6 120	3 760	9 013
	-3.0 m	kg	*11 600	*11 600	*16 610	*16 610	*16 130	10 200	11 210	6 630	7 980	4 850			6 970	4 270	8 256
	-4.5 m	kg	*17 380	*17 380	*20 560	*20 560	*14 460	10 420	*10 740	6 780					*8 480	5 400	7 102
	-6.0 m	kg			*15 040	*15 040	*10 660	*10 660							*8 610	*8 610	5 292

Notes: 1. Machine in "Fine Mode-F" (Power Boost) for lifting capacities. 2. The above loads are in compliance with SAE J1097 and ISO 10567 Hydraulic Excavator Lifting Capacity Standards. 3. Rated loads do not exceed 87% of hydraulic lifting capacity or 75% of tipping load. 4. Rated loads marked with an asterisk (*) are limited by hydraulic capacity rather than tipping load.

LIFTING CAPACITY EC300DLR

Lifting capacity at the arm end without bucket.

For lifting capacity including bucket, simply subtract actual weight of the direct fit bucket or the bucket with quick coupler from the following values.

	Lifting point		6.0 m		7.5 m		9.0 m		10.5 m		12.0 m		13.5 m		15.0 m		Max. reach		
			Along	Across	Along	Across	Along	Across	Along	Across	Along	Across	Along	Across	Along	Across	Along	Across	mm
Boom 10.2m	13.5 m	kg															*1 310	*1 310	12 934
Arm 7.9m	12.0 m	kg										*1 850	*1 850				*1 230	*1 230	14 137
Shoe 800mm	10.5 m	kg										*2 430	*2 430	*1 300	*1 300		*1 180	*1 180	15 094
CWT 6 400kg	9.0 m	kg										*2 750	*2 750	*2 030	*2 030		*1 160	*1 160	15 850
	7.5 m	kg										*2 850	2 720	*2 490	2 170		*1 160	*1 160	16 434
	6.0 m	kg									*3 120	*3 120	*3 000	2 620	*2 870	2 100	*1 160	*1 160	16 864
	4.5 m	kg							*3 640	*3 640	*3 380	3 110	*3 190	2 500	*3 050	2 020	*1 190	*1 190	17 151
	3.0 m	kg			*5 390	*5 390	*4 590	*4 590	*4 050	3 650	*3 680	2 920	*3 400	2 370	3 170	1 930	*1 230	*1 230	17 302
	1.5 m	kg	*8 160	7 430	*6 290	5 510	*5 190	4 260	*4 470	3 390	*3 980	2 740	*3 620	2 240	3 070	1 840	*1 280	*1 280	17 322
	0 m	kg	*9 280	6 670	*7 060	5 000	*5 730	3 920	*4 860	3 140	4 220	2 560	3 520	2 110	2 980	1 750	*1 360	1 330	17 209
	-1.5 m	kg	*10 020	6 180	*7 650	4 630	6 100	3 640	4 920	2 940	4 060	2 410	3 410	2 000	2 900	1 670	*1 460	1 330	16 963
	-3.0 m	kg	*9 880	5 910	*7 610	4 390	5 890	3 450	4 750	2 790	3 940	2 300	3 320	1 920	2 840	1 670	*1 600	1 370	16 576
	-4.5 m	kg	*10 430	5 800	*7 460	4 260	5 760	3 330	4 640	2 690	3 860	2 220	3 260	1 860	2 810	1 590	*1 780	1 430	16 039
	-6.0 m	kg	*10 400	5 790	*7 410	4 220	5 700	3 270	4 590	2 640	3 820	2 190	3 240	1 850	2 820	1 590	*2 040	1 540	15 336
	-7.5 m	kg	*10 030	5 870	*7 440	4 240	5 710	3 280	4 600	2 640	3 830	2 200	3 270	1 870			*2 400	1 720	14 442
	-9.0 m	kg	*9 400	6 020	*7 550	4 340	5 780	3 350	4 660	2 700	3 890	2 260					*2 980	1 990	13 318
	-10.5 m	kg	*8 440	6 260	*6 850	4 510	*5 670	3 490	*4 710	2 830							*3 860	2 420	11 898
	-12.0 m	kg	*7 000	6 600	*5 700	4 770	*4 630	3 720									*3 900	3 230	10 055

Notes: 1. Machine in "Fine Mode-F" (Power Boost) for lifting capacities. 2. The above loads are in compliance with SAE J1097 and ISO 10567 Hydraulic Excavator Lifting Capacity Standards. 3. Rated loads do not exceed 87% of hydraulic lifting capacity or 75% of tipping load. 4. Rated loads marked with an asterisk (*) are limited by hydraulic capacity rather than tipping load.

EQUIPMENT.

STANDARD EQUIPMENT

	EC250D	EC300D
Engine		
Turbocharged, 4 stroke diesel engine with water cooling, direct injection and charged air cooler	•	•
Air filter with indicator	•	•
Air intake heater	•	•
Cyclone pre-cleaner	•	•
Fuel filter and water separator	•	•
Alternator, 80 A	•	•
Electric/Electronic control system		
Contronics		
Advanced mode control system	•	•
Self-diagnostic system	•	•
Caretrack and 3yr-Caretrack subscription	•	•
Machine status indication	•	•
Engine speed sensing power control	•	•
Automatic idling system	•	•
One-touch power boost	•	•
Safety stop/start function	•	•
Adjustable LCD color monitor	•	•
Master electrical disconnect switch	•	•
Engine restart prevention circuit	•	•
High-capacity halogen lights:		
Frame-mounted 2	•	•
Boom-mounted 2	•	•
Batteries, 2 x 12 V / 200 Ah	•	•
Start motor, 24 V / 5.5 kW	•	•
Hydraulic system		
Automatic sensing hydraulic system		
Summation system	•	•
Boom priority	•	•
Arm priority	•	•
Swing priority	•	•
ECO mode fuel saving technology	•	•
Boom, arm and bucket regeneration valves	•	•
Swing anti-rebound valves	•	•
Boom and arm holding valves	•	•
Multi-stage filtering system	•	•
Cylinder cushioning	•	•
Cylinder contamination seals	•	•
Auxiliary hydraulic valve	•	•
Automatic twospeed travel motors	•	•
Hydraulic oil, ISO VG 46	•	•
Frame		
Access way with handrail	•	•
Tool storage area	•	•
Punched metal antislip plates	•	•
Undercover	•	•
Cab and Interior		
Travel pedals and hand levers	•	•
Adjustable operator seat and joystick control console	•	•
Control joysticks	•	•
Heater & air-conditioner, automatic	•	•
Flexible antenna	•	•
AM/FM stereo with CD player, MP3 and USB input	•	•

	EC250D	EC300D
Cab and Interior		
Control lock-out lever	•	•
Cab, all-weather sound suppressed, includes:		
Cup holders	•	•
Door locks	•	•
Tinted glass	•	•
Floor mat	•	•
Horn	•	•
Large storage area	•	•
Pull-up type front window	•	•
Removable lower windshield	•	•
Seat belt	•	•
Safety glass	•	•
Windshield wiper with intermittent feature	•	•
Master key	•	•
Sun screens, front, roof, rear	•	•
Undercarriage		
Undercover	•	•
Hydraulic track adjusters	•	•
Greased and sealed track link	•	•
Track Guard	•	•
Digging equipment		
Linkage	•	•

OPTIONAL EQUIPMENT

	EC250D	EC300D
Engine		
Block heater: 240 V	•	•
Oil bath pre-cleaner	•	•
Diesel coolant heater, 10 kW	•	•
Water separator with heater	•	•
Extra water separator	•	•
Auto engine shutdown	•	•
Fuel filler pump: 35 lpm	•	•
Electric		
Extra work lights:		
Cab-mounted 3 (front 2, rear 1)	•	•
Counterweight-mounted 1	•	•
Travel alarm	•	•
Anti-theft system	•	•
Rotating warning beacon	•	•
Air compressor	•	•
Hydraulic system		
Hose rupture valve: boom, arm	•	•
Overload warning device	•	•
Boom float function with HRV	•	•
Boom float function without HRV	•	•
Hydraulic piping:		
Attachment management system (up to 20 programmable memories)	•	•
Breaker & shear, 1 and 2 pump flow	•	•

OPTIONAL EQUIPMENT

	EC250D	EC300D
Hydraulic system		
Hydraulic piping:		
Breaker & shear: variable flow and pressure pre-setting	•	•
Additional return filter	•	•
Slope & rotator	•	•
Grapple	•	•
Oil leak (drain) line	•	•
Quick coupler piping	•	•
Volvo hydraulic quick coupler S1	•	
Volvo hydraulic quick coupler S2	•	•
Volvo hydraulic quick coupler S2 narrow	•	
Volvo hydraulic quick coupler U24, RQC-OC, ED24	•	
Volvo hydraulic quick coupler U29, U29 wide, RQC-OC ED29		•
Hydraulic oil, ISO VG 32, 68	•	•
Hydraulic oil, longlife oil 32, 46, 68	•	•
Cab and Interior		
Silicon oil and rubber mounts with spring	•	•
ROPS (ISO12117-2) certified cab	•	•
Fabric seat with heater	•	•
Fabric seat with heater and air suspension	•	•
Opening top hatch	•	•
Cab-mounted falling object guard (FOG)	•	•
Cab-mounted falling object protective structure (FOPS)	•	•
Smoker kit (Ashtray and lighter)	•	•
Safety net for front window	•	•
Front rain shield	•	•
Sun shield, roof hatch (steel)	•	•
Lower wiper with intermittent control	•	•
Anti-vandalism kit	•	•
Rear view camera	•	•
Specific key	•	•
Undercarriage		
Full track guard	•	•
Track shoes		
600/700/800/900 mm with triple grousers	•	•
Track shoes 600 mm HD with triple grousers	•	•
Track shoes 700 mm with double grousers	•	•
Frame		
Rear view mirror on counterweight	•	•
Full height counterweight:		
4 250kg, 4 950kg	•	
6 200kg for long reach	•	
5 100kg, 5 500kg		•
6 800kg for long reach		•
Digging equipment		
Boom: 6.0 m monoblock, 5.95 m 2 piece boom	•	
Boom: 10.2 m long reach	•	
Arm: 2.5 m, 2.97 m, 3.6 m	•	
Arm: 7.85 m, long reach	•	
Boom: 6.2 m monoblock, 6.2 m 2 piece boom		•
Boom: 10.2 m, long reach		•
Arm: 2.55 m, 2.75 m, 3.05 m, 3.7 m		•
Arm: 7.9 m long reach		•
Service		
Tool kit, daily maintenance	•	•
Tool kit, full scale	•	•

SELECTION OF VOLVO OPTIONAL EQUIPMENT

Boom float	
Oil bath pre cleaner	
Additional work lights	
X1 presets	
Diesel-driven engine coolant heater	
Siberian kit	

VOLVO CONSTRUCTION EQUIPMENT

Volvo Construction Equipment is different. Our machines are designed, built and supported in a different way. That difference comes from an engineering heritage of over 180 years. A heritage of thinking first about the people who actually use the machines. About how to help them be safer, more comfortable, more productive. About the environment we all share. The result of that thinking is a growing range of machines and a global support network dedicated to helping you do more. People around the world are proud to use Volvo.

Not all products are available in all markets. Under our policy of continuous improvement, we reserve the right to change specifications and design without prior notice. The illustrations do not necessarily show the standard version of the machine.

VOLVO

Volvo Construction Equipment
www.volvoce.com

Ref. No 20035491-B
2013.05
Volvo, Global Marketing

English-30
EXC